

Auto door sensor

■ Features

- Stop time selection function
(Selectable stop time 2 / 7 / 15sec.)
- 4 steps variable function for front detecting area
(7.5°, 14.5°, 21.5°, 28.5° 4steps variable)
- Right/Left detecting area elimination function
- Simple design and various cover color
 - Standard : Silver
 - Option : Black, White, Bronze, Nickel)
- Wide range of power supply
(24-240VAC/24-240VDC, 12-24VAC/12-24VDC)
- Micro processor built in



! Please read "Caution for your safety" in operation manual before using.

■ Specifications

Model	ADS-AF	ADS-AE
Cover color	Silver(Optional color : Black, White, Bronze, Glossy, Nickel)	
Power supply	24-240VAC ±10% 50/60Hz, 24-240VDC ±10% (Ripple P-P:Max. 10%)	12-24VAC ±10% 50/60Hz, 12-24VDC ±10% (Ripple P-P:Max. 10%)
Power consumption	Max. 4VA at 240VAC	Max. 2VA at 24VAC
Control output	(*1) Relay contact output [Relay contact capacity : 50VDC 0.1A(Resistive load) Relay contact composition : 1a	
Relay life cycle	Mechanical : Min. 20,000,000, Electrical : Min. 50,000	
Mounting height	2.0m ~ 2.7m(Max. detecting distance : 3m)	
Detection method	Infrared reflection method(Diffuse reflective type)	
Output delay time	Time delay approx. 0.5sec.	
Output holding time	Selectable 2 / 7 / 15sec. by slide switch	
Interference prevention	H, L(Interfearence prevention switch)	
Front detecting area	7.5° , 14.5° , 21.5° , 28.5° : Adjust angle adjustment lever	
Adjustable detection area	(1, 2, 3 Area), (7, 8, 9 Area) Eliminate each by each : Adjustment with switch for eliminate Right/Left detecting area	
Light source	Infrared chip diode(modulated)	
Indicator	Normal : Red LED turns on, Detection : Red LED turns off	
Connection method	Connector wire connection	
Insulation resistance	Min. 20MΩ (at 500VDC)	
Noise strength	±2,000V the square wave noise(pulse width:1μs) by the noise simulator	
Dielectric strength	1,000VAC 50/60Hz for 1 minute	
Vibration	1.5mm amplitude at frequency of 10 ~ 55Hz in each of X, Y, Z directions for 2 hours	
Shock	100m/s ² (Approx. 10G) in X, Y, Z directions for 3 times	
Ambient illumination	Sunlight : Max. 11,000lx, Incandescent lamp : Max. 3,000lx	
Ambient temperature	-20℃ ~ +50℃ (at non-freezing status), Storage : -20 ~ +70℃	
Ambient humidity	35 ~ 85%RH, Storage : 35 ~ 85%RH	
Accessories	Cable : 2.5m, Mounting screw : 2EA, Mounting template	
Protection	IP50(IEC specification)	
Material	Case : ABS, Lens : Acryl, Lens cover : Acryl	
Weight	Approx. 320g	

※(*1)Don't use Load which is beyond the correct switching capacity of contact point of Relay.
It can cause bad insulation, contact fusion, bad contact, relay breakdown, fire etc.

(A)
Counter

(B)
Timer

(C)
Temp.
controller

(D)
Power
controller

(E)
Panel
meter

(F)
Tacho/
Speed/
Pulse
meter

(G)
Display
unit

(H)
Sensor
controller

(I)
Proximity
sensor

(J)
Photo
electric
sensor

(K)
Pressure
sensor

(L)
Rotary
encoder

(M)
5-Phase
stepping
motor &
Driver &
Controller

ADS-A

Parts description

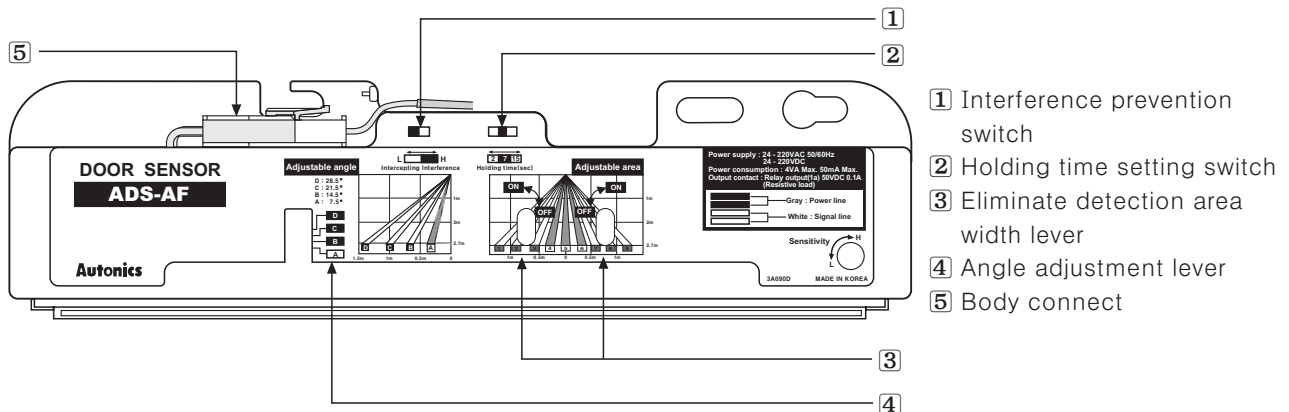

Dimensions

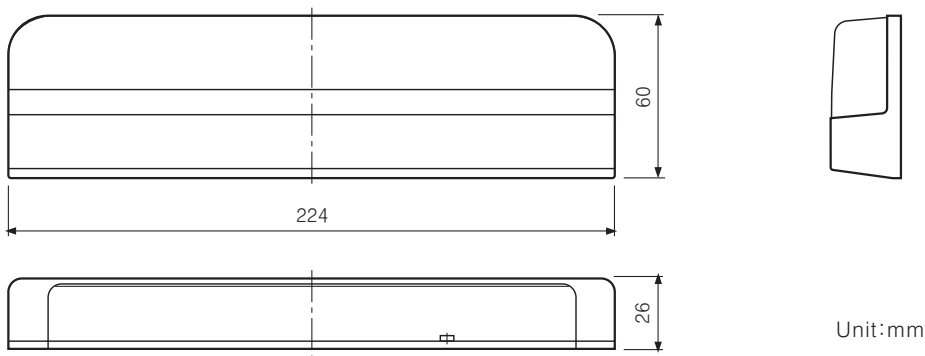

Installation

Installation	⚠ Caution
<p>1. Attach mounting template at mounting position (Mounting height : 2.0m ~ 2.7m)</p> <ul style="list-style-type: none"> • Drill ϕ 3.4mm hole based on mounting template. • In case of wiring the cable on the wall to hide the cable, drill ϕ 9mm hole. • Install the unit after removing the mounting template. <p>Max. 2.7m</p> <p>Mounting hole</p> <p>Center</p> <p>Hole for inside cable connection</p> <p>Mounting template</p>	<p>⚠ Warning It may give an electric shock.</p> <ul style="list-style-type: none"> • When this unit is used with cable outlet removed from cover, it must be installed indoors. (Electric shock or damage can occur if water flows through cable outlet.) <p>⚠ Caution People can be jammed in the door.</p> <ul style="list-style-type: none"> • If unit is installed higher than 2.7m in height, it may not detect children. • If unit is installed lower than 2.0m in height, it may not work properly.

Auto Door Sensor

Installation

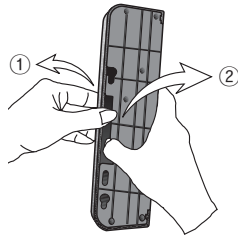
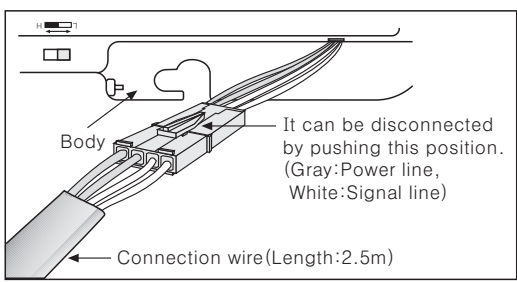
Installation	⚠ Caution
<p>2. Please install this unit with mounting screws after removing protection cover.</p> 	<p>⚠ Caution Mounting the unit</p> <ul style="list-style-type: none"> Do not put excessive tightening torque on screw bolt when mounting this unit. It may result in mounting hole damage. <p><Protection cover detachment></p> <ul style="list-style-type: none"> Pulling left thumb toward ①, key lock will be released and pull right thumb toward ②, protection cover and body will be detached.
<p>3. The code part of wiring code should be connected to main control part.</p> <ul style="list-style-type: none"> Install the connector to be connect to the body. 	
<p>4. Connect the extension cable and the main controller.</p>  <p>It can be disconnected by pushing this position. (Gray: Power line, White: Signal line)</p> <p>Body</p> <p>Connection wire (Length: 2.5m)</p>	<p>⚠ Caution Connection of the connector</p> <ul style="list-style-type: none"> Plug in the connector of the extension cable and the connector of the unit completely. The unit may not work normally with inferior contact.

(A) Counter

(B) Timer

(C) Temp. controller

(D) Power controller

(E) Panel meter

(F) Tacho/ Speed/ Pulse meter

(G) Display unit

(H) Sensor controller

(I) Proximity sensor

(J) Photo electric sensor

(K) Pressure sensor

(L) Rotary encoder

(M) 5-Phase stepping motor & Driver & Controller

Adjustment

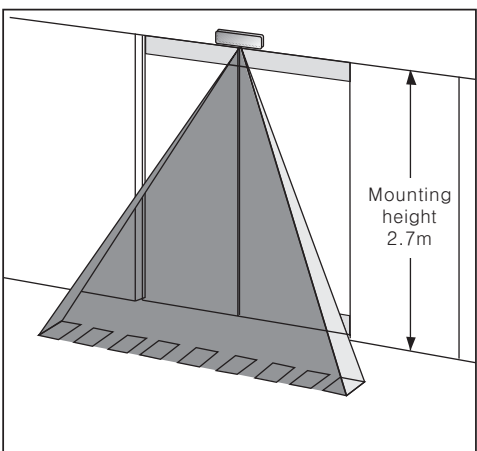
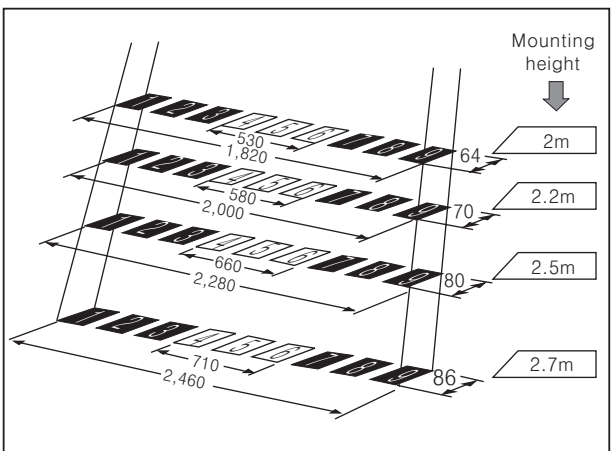
Please turn on the power.	
<p>1. Check of the detection area</p> <p>This characteristic of the detection area is shown in below chart and drawing.</p>  <p>Mounting height 2.7m</p>	<p>(Unit: mm)</p>  <p>Mounting height</p> <p>2m</p> <p>2.2m</p> <p>2.5m</p> <p>2.7m</p>

Adjustment

2. Adjustable detection area

Adjustable 7° in each step.
(Detection area angle step : 7.5° ~ 28.5°)

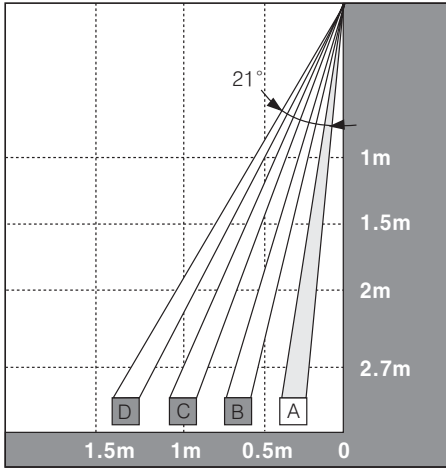
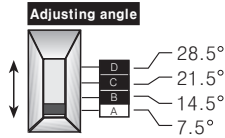

⚠ Caution People can be jammed in the door.

- Be sure to install a photo sensor as the safe equipment. There is ADS-SE series for a Door side sensor.
- Even if the unit is installed at narrow area from the door, the rail of the door is dangerous.

3. Adjustment of Left, Right detection area width

Detection area width ①②③ can be eliminated by left lever, ⑦⑧⑨ by right lever. □

- Use the unit as removing non-detection area by the lever adjusting width at narrow detection area.

※Turn the adjuster till it stops it toward arrow direction by a (-) driver.

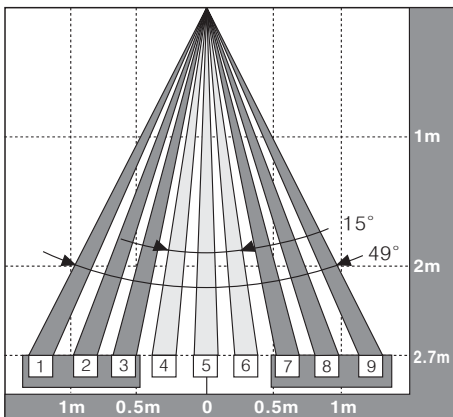
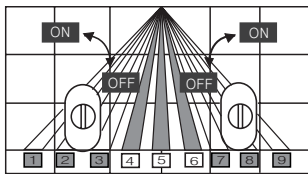

⚠ Caution People may run against the door.

- When eliminating the Right/Left detecting range, be sure to install the unit at place where a person approaches at the front of the door.
If case of eliminating detection area width:
- If a person approaches at the side of the door, they may not be detected and the door will not open.

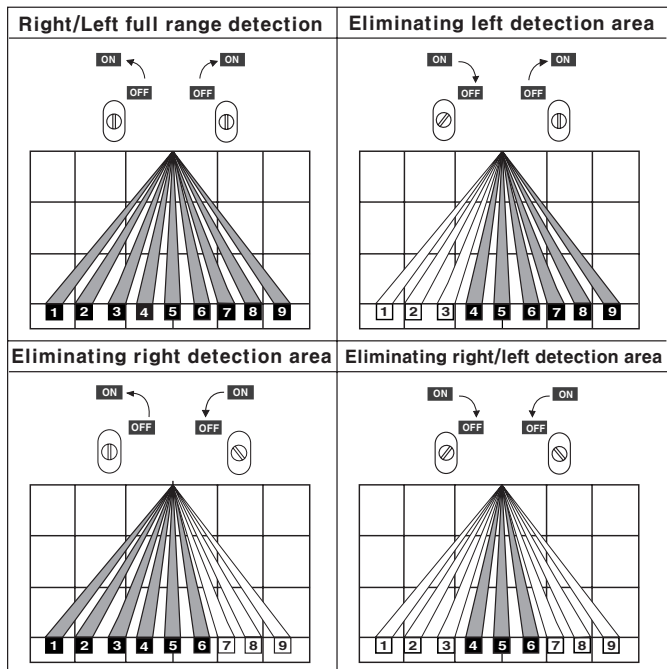

※You can not eliminate individual areas like ① area elimination, ⑦ area elimination.

Adjustment

4. How to set the switch for interference prevention

In case of using several door sensors in close proximity, please set the interference prevention switches differently.

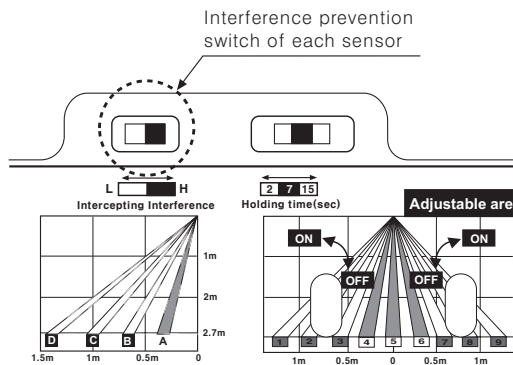

⚠ Caution Door can be opening and closing

When several door sensors are installed simultaneously without considering any interference detection, it may cause malfunction by another door sensor even though no moving object exists.

< Interference prevention >

If detection area of the door sensors is overlapped, set each switch in difference or install the unit on non-overlapped detection area.

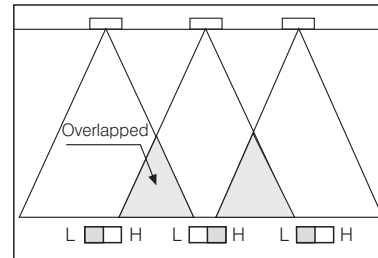

5. Holding time switch setting

You can set the holding time by the Holding time switch. (Selectable 2 / 7 / 15sec.)

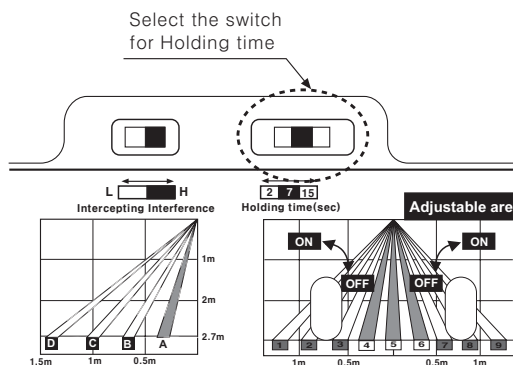

⚠ Caution People can be jammed in the door.

- Be sure to install a assisting sensor as a safe equipment. There is ADS-SE series for a Door side sensor.
- The door will close after the time set by the holding time switch has elapsed.

<Holding time>

- When people or objects stay in detection area after auto tuning (Set 7sec. for Holding time), it will detect the stationary people or objects for set time by the holding time switch, and then the sensor's output turns off after set time.)

6. Sensitivity Setting

Even though people in the detection area, if the sensor don't operated, turning the volume toward to H. The sensitivity will be increased.



Even though people in the detection area, if the sensor operated, turning the volume toward to L. The sensitivity will be Decreased.

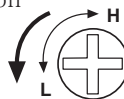

⚠ Caution Door can be opening and closing

Please check the normal operation by turning the power ON/OFF after finishing the sensitivity setting.

It any not operate normally because the install setting is changed before and after sensitivity setting

7. Unit cover

- Mount the cover on the unit.
- In case of using outlet to wire exposed cable, take off point.

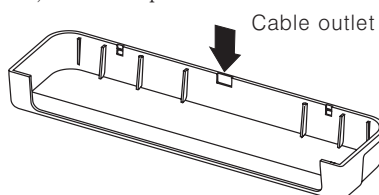

⚠ Warning It may give an electric shock.

- Do not take off its cover on operating the unit.
- In case of using the cable outlet, the unit must be installed in inner position of door.
- Be sure that this unit does not come in direct touch with water. It may cause human injury or give an electric shock.

(A) Counter

(B) Timer

(C) Temp. controller

(D) Power controller

(E) Panel meter

(F) Tacho/Speed/Pulse meter

(G) Display unit

(H) Sensor controller













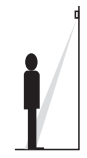











(I) Proximity sensor

(J) Photo electric sensor

(K) Pressure sensor

(L) Rotary encoder

(M) 5-Phase stepping motor & Driver & Controller

7. Sensitivity After turning the power, please stand by in the condition in which there is no moving object in the detection area.		• If don't pass about 3 sec after turning the power, holding detection is impossible				
8. Check of detecting operation Check detecting operation as follow drawing.						
Entry activation						
Operation indicator	Orange	LED ON 	LED OFF 	LED OFF 	LED OFF 	LED OFF 
	Green	LED OFF 	LED ON 	LED OFF 	LED ON 	LED ON 
	Red	LED OFF 	LED OFF 	LED ON 	LED OFF 	LED OFF 
Output contact					Output : ON for holding time 	Output : OFF after 0.5sec. 
9. Maintenance <ul style="list-style-type: none"> • If the detection lens is unclean, the unit may cause malfunction, in this case, please clean it with dry tissue and natural detergent. • Do not use an organic cleaner such as benzene, etc. 			⚠ Caution It may give an electric shock. <ul style="list-style-type: none"> • Do not wash the unit with water. • Do not repair or disassemble the unit. 			

■ Trouble shooting

Trouble	Check	Correction action
It does not work.	<ul style="list-style-type: none"> ● Power voltage ● Cable cut, disconnection 	<ul style="list-style-type: none"> ● Check the power cable and adjust power voltage. ● Check connector and wiring.
Sometimes it does not work.	<ul style="list-style-type: none"> ● The detection lens is unclean 	<ul style="list-style-type: none"> ● Clean it with dry tissue and natural detergent.
It operates even if people do not enter in detection area.	<ul style="list-style-type: none"> ● There are moving objects. ● By occurring sudden change of bottom surface. ● Detection area is overlapped. ● There is equipment causing strong noise. ● A drop of water is placed at the lens. 	<ul style="list-style-type: none"> ● Check status of installation. ● Check surrounding environment for installation. ● Install the unit to avoid overlap for detection area. ● Set the switch intercepting interference. ● Do not install the equipment producing strong noise near the sensor. ● Remove a drop of water.

Auto Door Sensor

Installation

1. This product is not qualified for waterproof. Please install without being directly contacted with rain or snow. It may cause breakdown and short circuit.

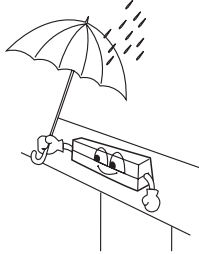

2. Don't install where reflecting light like sunshine directly reaches. It may don't operate normally.

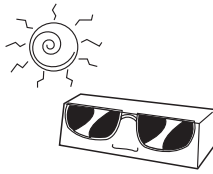

3. Don't install where smoke and vapor occurs. It may don't operate normally.

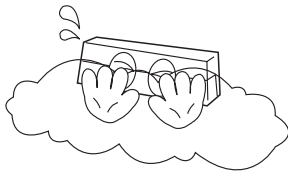

4. If you place a movable object in the detection area, it may cause malfunction by detecting the object because of natural phenomenon like wind etc.



5. Detection hole must face the bottom, if not, the sensor doesn't operate normally.

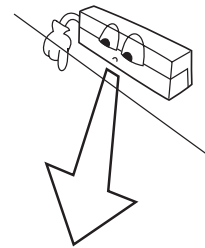

Caution for using

Warning It may give an electric shock.

Do not take off its cover when the unit is operating. Be sure that this unit does not come in direct contact with water.

- When using this unit with cable outlet removed, this unit must be installed indoors. If installed outdoors, it may give an electric shock or damage by direct contact with water when the water inflows through cable outlet.
- Do not wash the unit with water. Be sure that this unit does not come in direct contact with water. It may cause damage or give an electric shock.
- Do not repair or disassemble the sensor. It may cause damage or give an electric shock.

Caution Be careful of human injury by the door.

- Do not install this unit at place higher than 2.7m. It may not detect small children due to lack of sensitivity.
- Do not install this unit under 2m. It may not operate normally.
- Please install photo sensor as the safety equipment, the door will close after passing Holding time. It may not be able to detect children or old people continuously and jammed in the door.
- Please install photo sensor as the safety equipment. This unit holds the door for Holding time. When the Holding time passed, the door will be closed. People may be jammed in the door.

Caution Door may not open

- When eliminate the Right/Left detecting range, be sure to install the unit at place where a person approaches at the front of the door. If a person approaches at the side direction of the door, the door may not open because the person is not within detection area width.

Caution It may cause malfunction.

- When wiring the photoelectric sensor with high voltage line, power line in the same conduit, it may cause malfunction. Therefore please wire separately or use different conduit.
- Do not install this unit at place where there is dust or corrosive gas.
- The wire connection shall be used as short as possible in order to avoid malfunction by surge.
- When it is covered by dirt at lens, please clean the lens with dry cloth, but do not use any organic materials such as alkali, acid, chromic acid.

(A)
Counter

(B)
Timer

(C)
Temp.
controller

(D)
Power
controller

(E)
Panel
meter

(F)
Tacho/
Speed/
Pulse
meter

(G)
Display
unit

(H)
Sensor
controller

(I)
Proximity
sensor

(J)
Photo
electric
sensor

(K)
Pressure
sensor

(L)
Rotary
encoder

(M)
5-Phase
stepping
motor &
Driver &
Controller